

Reliability is our target

# PAN WORLD SEALLESS MAGNETIC DRIVEN SELF PRIMING PUMP

**PW-N** Series(PPG)  
**PW-N-F** Series(PVDF)



PAN WORLD CO., LTD.

# Features

- Precision injection part, glass-fiber reinforced PP or carbon fiber reinforced PvdF.
- Advanced design with gas and liquid separated construction.
- Heavy duty , Reliability
- Available in 5 models with max flow rate of 600 lit/min.
- Max suction lift head up to 4 m.
- Adaptable with world wide motor as standard and pipe connection.



## The most advanced pump has progressed next step

### Rear Casing

Hollow spindle of rear casing is increased durability during self priming process and expect easy gas removal.



### Filter

The gas and substance are easily separated.

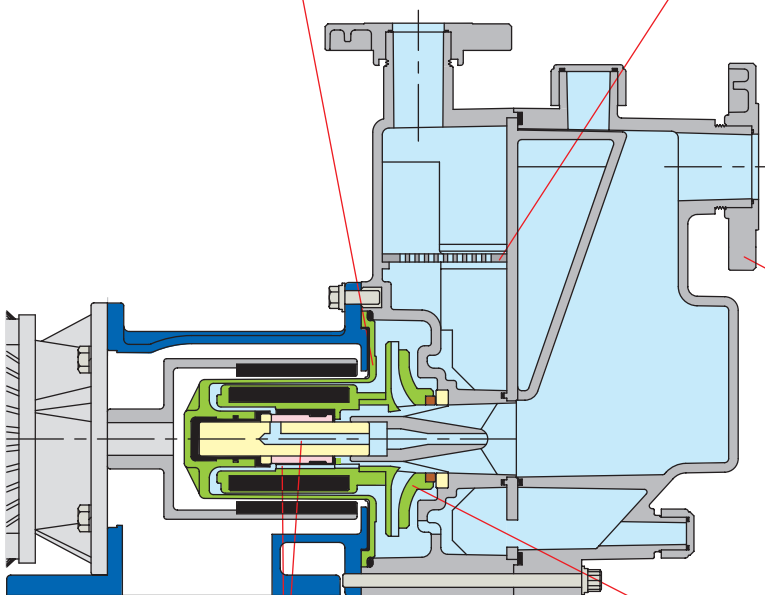
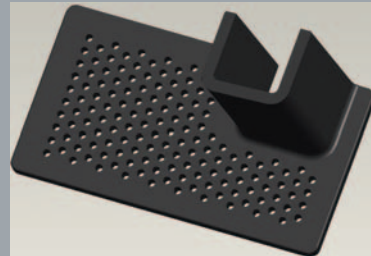

### Connection method

ISO/ANSI/JIS/CNS Flange are available  
BS Thread & NPT Thread, also available.



Special cooling structure is designed for abrasion parts to get higher reliability and easy gas removal.



### Special Impeller Vane

In order to get easy self-priming, special impeller are designed.



# Principles of Self-priming

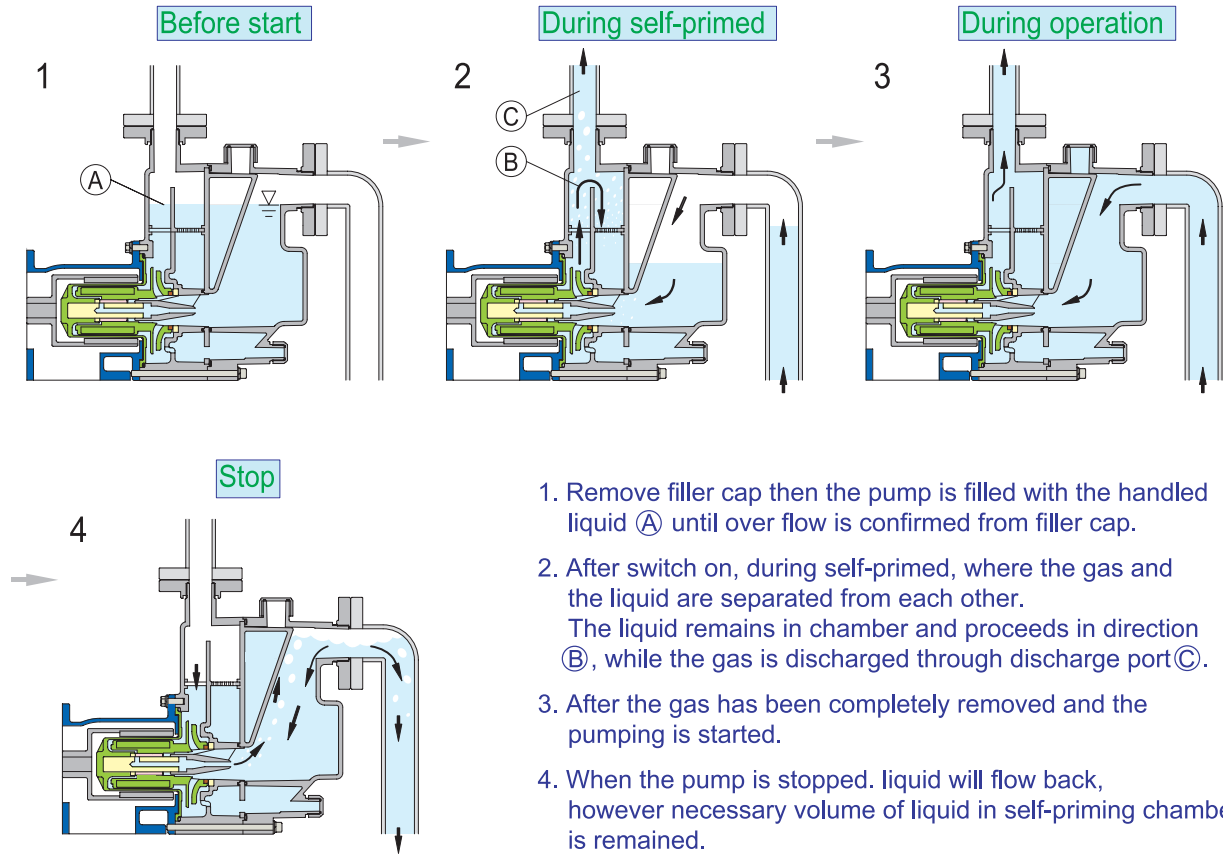

1. Remove filler cap then the pump is filled with the handled liquid (A) until over flow is confirmed from filler cap.
2. After switch on, during self-primed, where the gas and the liquid are separated from each other. The liquid remains in chamber and proceeds in direction (B), while the gas is discharged through discharge port (C).
3. After the gas has been completely removed and the pumping is started.
4. When the pump is stopped. liquid will flow back, however necessary volume of liquid in self-priming chamber is remained.

# Typical Application

A. Suck the liquid from negative tank under ground, or to transfer pump can install higher than tank, wasted chemical to wasted chemical treatment.

B. No need and drum pump on the tank, pipe could reach to liquid from the top of tank.

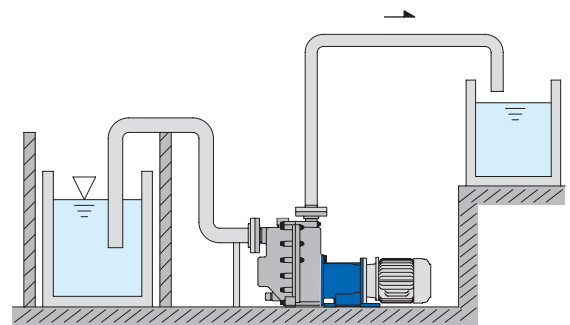
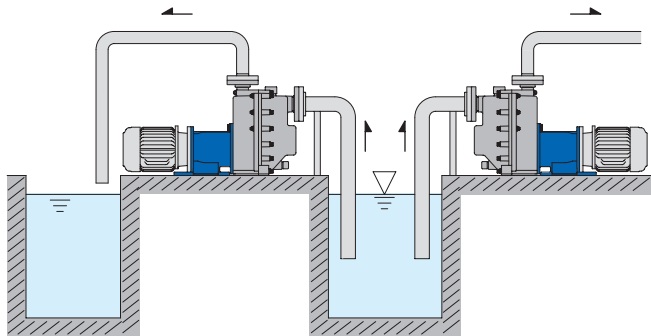

C. Liquid is transferred from vessel or tank under ground to higher level.

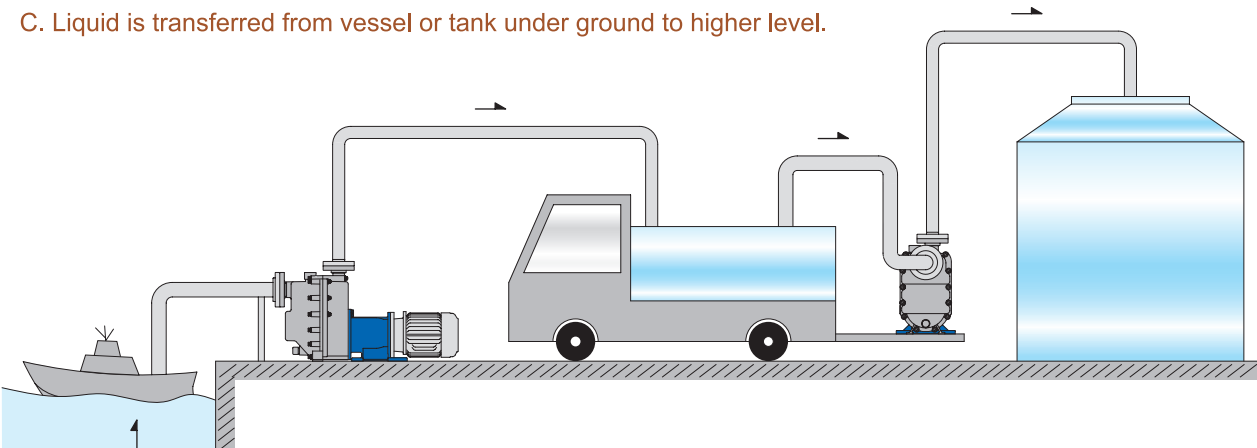

# Type Indication

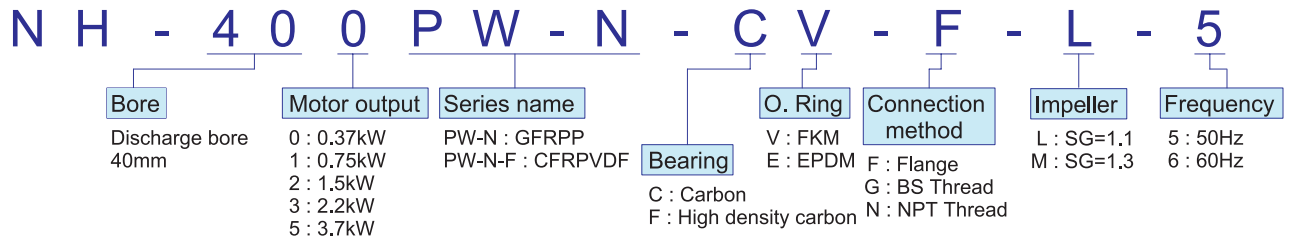

# Parts List

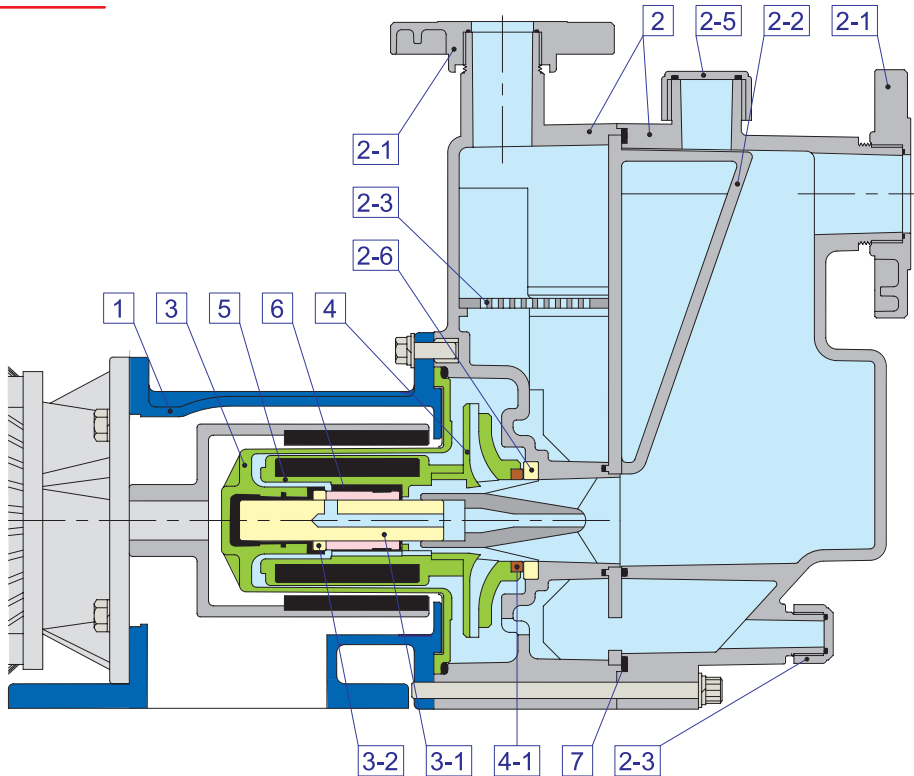

Name of part	Model	NH-400/401/402/403/405PW-N		NH-400/401/402/403/405PW-N-F
		CV	CE	FV
1. Bracket		FC 200		FC 200
2. Self-priming chambers		GFRPP		CFRPVDF
2-1. Flange				
2-2. Telescopic piece				
2-3. Filter				
2-4. Drain cap				
2-5. Filler cap				
2-6. Thrust pad		99.5% Alumina ceramic	99.5% Alumina ceramic	
3. Rear casing		GFRPP		CFR ETFE
3-1. Spindle		99.5% Alumina ceramic		99.5% Alumina ceramic
3-2. Rear thrust pad		99.5% Alumina ceramic		99.5% Alumina ceramic
4. Impeller		GFRPP		CFR ETFE
4-1. Mouth ring		Rulon LD		Rulon LD
5. Magnet capsule		GFRPP		CFR ETFE
6. Bearing		Carbon		High density carbon
7. Gasket		FKM	EPDM	FKM
8. O. Rings		FKM	EPDM	FKM

# Specification table

Model	Connection Method		S.G.	Performance , 50/60Hz		Max Self Priming Lift head at S.G 1.0 (m)	Motor kW 2860/3440
	Flange(mm) In x Outlet	B. Thread (") In x Outlet		Capacity-discharge head at specified point (l/min at m)	Max capacity - max discharge (L/Min - m)		
NH-400PW-N	40A x 40A	1 1/2" x 1 1/2"	1.1	140 at 7 / 140 at 6	240-10.5 / 240-9.5	3	0.37
			1.3	160 at 5 / 120 at 6	200-8.5 / 200-8.5		
NH-401PW-N	40A x 40A	1 1/2" x 1 1/2"	1.1	200 at 10 / 200 at 8	320-16 / 320-15	3.3	0.75
			1.3	160 at 10 / 160 at 9	290-14 / 290-12.5		
NH-402PW-N	50A x 40A	2" x 1 1/2"	1.1	250 at 16 / 250 at 16	470-24.5 / 470-20.5	4	1.5
			1.3	265 at 14 / 265 at 13	450-22 / 450-19		
NH-403PW-N	50A x 40A	2" x 1 1/2"	1.1	280 at 21 / 290 at 19	570-26 / 570-23	4	2.2
			1.3	240 at 18 / 240 at 18	550-23 / 550-21		
NH-405PW-N	50A x 40A	2" x 1 1/2"	1.1	330 at 25 / 330 at 26	600-32 / 600-32.5	4	3.7
			1.3	330 at 25 / 320 at 23	600-32 / 570-31		

1. Max self-priming lift head is shown when horizontal pipe length of section inlet is max 0.5m.

2. Max self-priming lift head is S.G. at 1.0

# Installation dimension

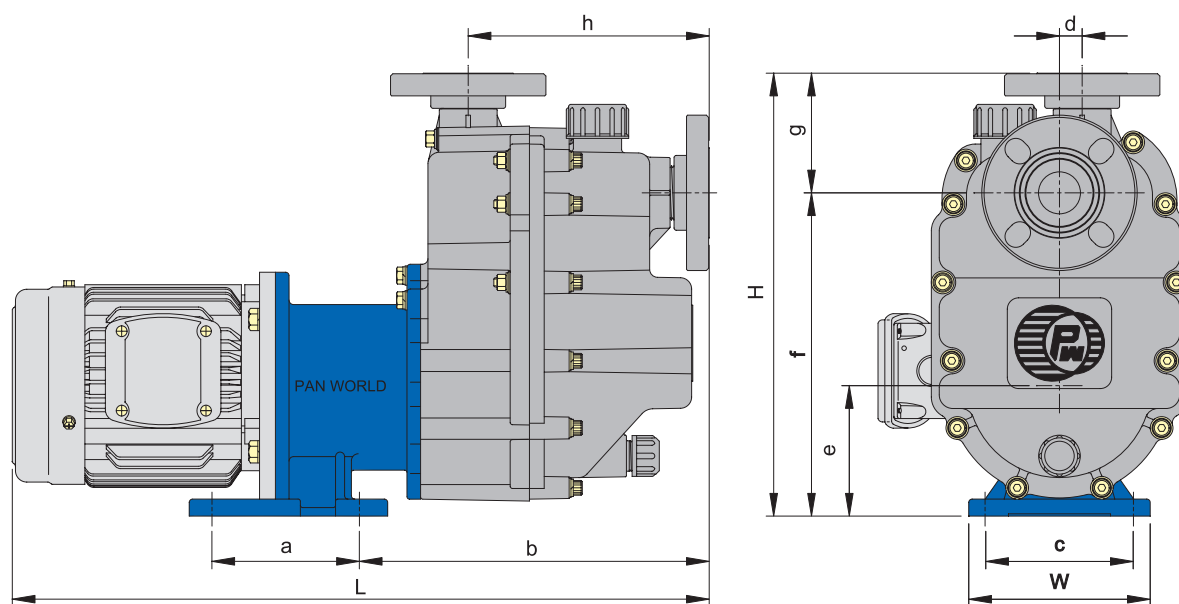

Dimensions in mm

Model	W	H	L	a	b	c	d	e	f	g	h
NH-400PW-N	160	390	613	130	308	130	20	115	285	105	212
NH-401PW-N	160	390	615	130	308	130	20	115	285	105	212
NH-402PW-N	260	420	794	200	333	208	30	115	315	105	250
NH-403PW-N	260	420	794	200	333	208	30	115	315	105	250
NH-405PW-N	260	435	866	200	333	208	30	130	330	105	250

Remark : 1. The size in above table is shown with IEC motor.

2. Over all size & construction may be changed without notice.

# Performance curve ( for reference )

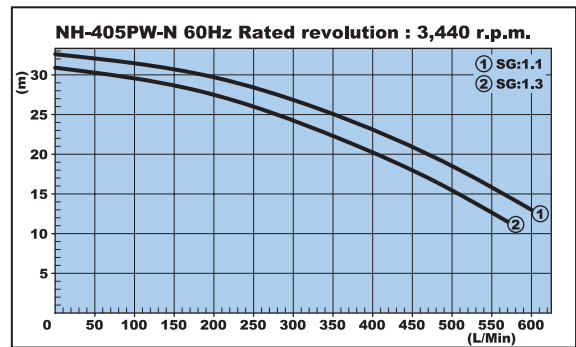
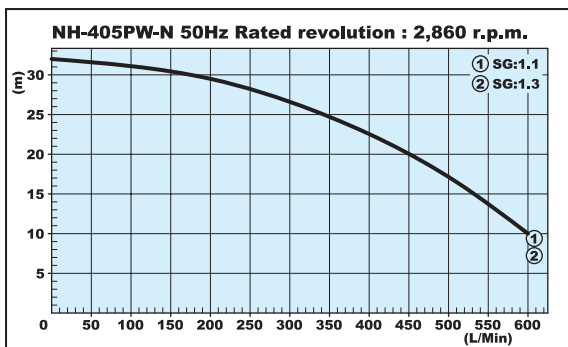
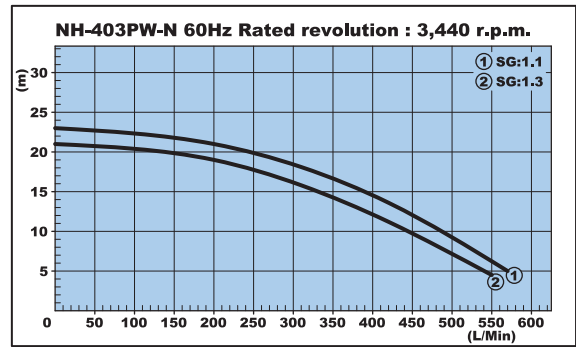
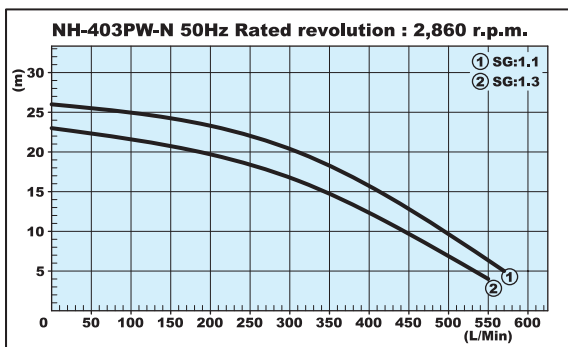
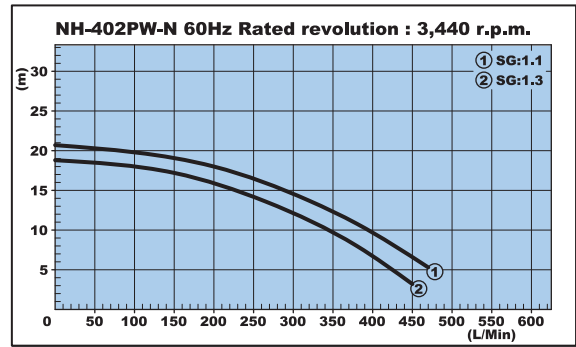
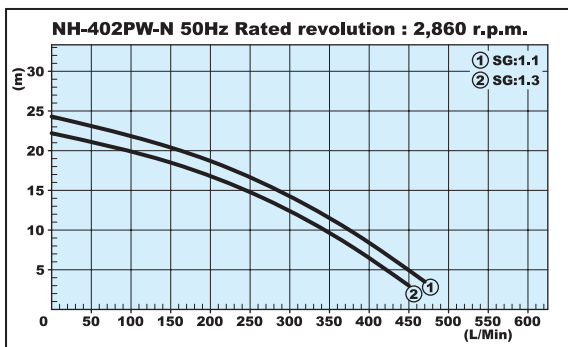
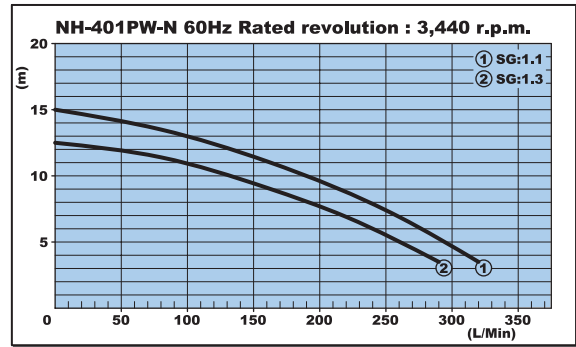
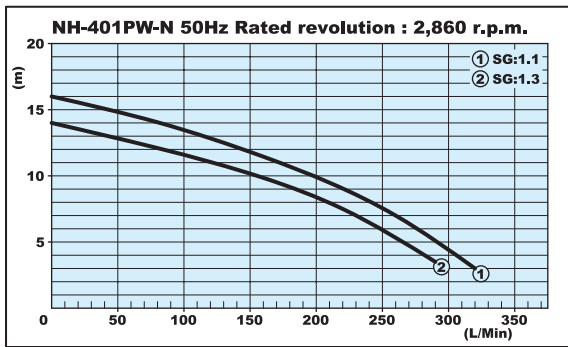
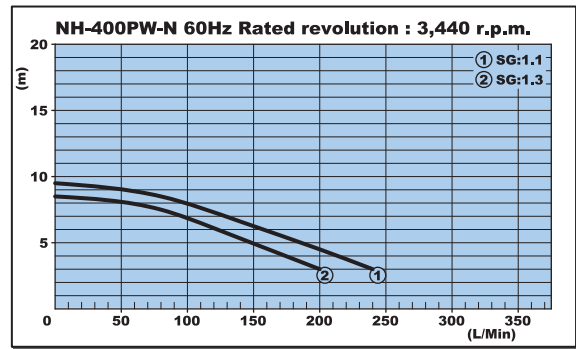
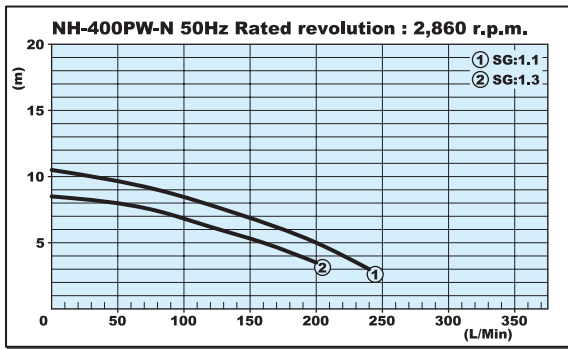

Note : In case of performance of PW-N-F, they are totally same performance curves of above PW-N.

## Precautions on pump selection

1. The self-priming performance ( self-priming of 4 m within 4 minutes ) represents the data with fresh water for 0~40°C. The self-priming performance will be fluctuated with the liquid temperature, type of liquid, suction piping conditions, and other factors. To determine the maximum self-priming height to suction be handled different heavy chemical S.G viscosity, refer to the following equation.

- Self-priming static height of different specific gravity liquids = 
$$\frac{\text{self-priming height of fresh water (m)}}{\text{Specific gravity of liquid.}}$$
- Please take vapour pressure at 0~10°C when liquid is over 0~40°C.

2. Try to ensure the following suction conditions to prevent cavitation.

- $NPSH_a \geq NPSH_r + 0.5\text{m}$  ( Margin )

3. Magnetic drive pump can not run dry or totally closed discharge valve, and a minimum discharge flow is required as the following.

400/401 : 10 L/min, 402/403/405 : 20 L/min as far as can be controlled by discharge valve.

4. The performance curve shown by fresh water 0~40°C.

## Recommendation

1. The diameter of suction pipe should be the same size of pump inlet port.

(400/401: 3m, 402/403/405 : 4m)

2. In cases where the liquid level fluctuates, install level stabilizer.

3. The pump chamber is required to fill with the handled liquid at first initial operation.

- Priming water volume : Approx.  
400/401 : 5.7 L, 402/403/405 : 8.0 L.

## Limitation of slurry to be handled

Concentration : 5 %

Particle size : 50  $\mu$  mm

Hardness : HS 80 degree ( HRC 59.2 )

Note : 1. Flush pump inside regularly.

2. The lowest temp. of chemical allowed is 0°C.

3. Allowable environment condition 0~40°C , 35~85%.

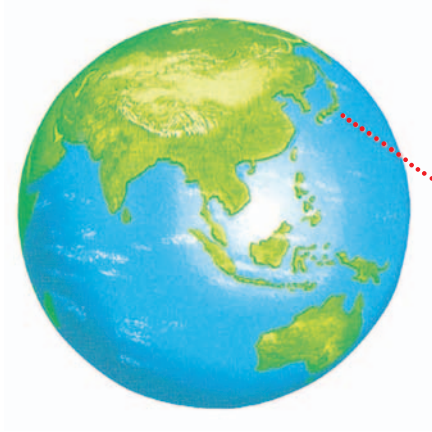

## PAN WORLD GROUP OF COMPANIES

Pan World Co., Ltd. ( Japan )

TPW, Hong Yuan Co., Ltd. ( Taiwan )  
ISO 9001 Certified

Pan World Asia Pacific Pte., Ltd. ( Singapore )  
ISO 9001 Certified

VHP INC. ( Philippines )

Jen Fu Co., Ltd. ( Taiwan )

Pan World ( M ) SDN BHD. ( Malaysia )

PT. Capmarindo Utama ( Indonesia )

Pan World America INC. ( U. S. A )

Pan World - Thailand Co., Ltd. ( Thailand )

Shenzhen Rongchao Industry Co., Ltd.  
( Guangzhou, China )

Shinfu Mechanical Co., Ltd. ( Shanghai, China )



PAN WORLD CO LTD  
1097-18, MITSUKAIDO YAMADA-CHO  
JYOUSOU-SHI, IBARAKI-KEN, JAPAN  
TEL : (81) 2972 3 5560  
FAX : (81) 2972 3 5561  
Email : aricomx@mx5.nisq.net  
http : www.panworld-jp.com

Specifications are subjected to changes without prior notice.

AH-EU-RH1116